

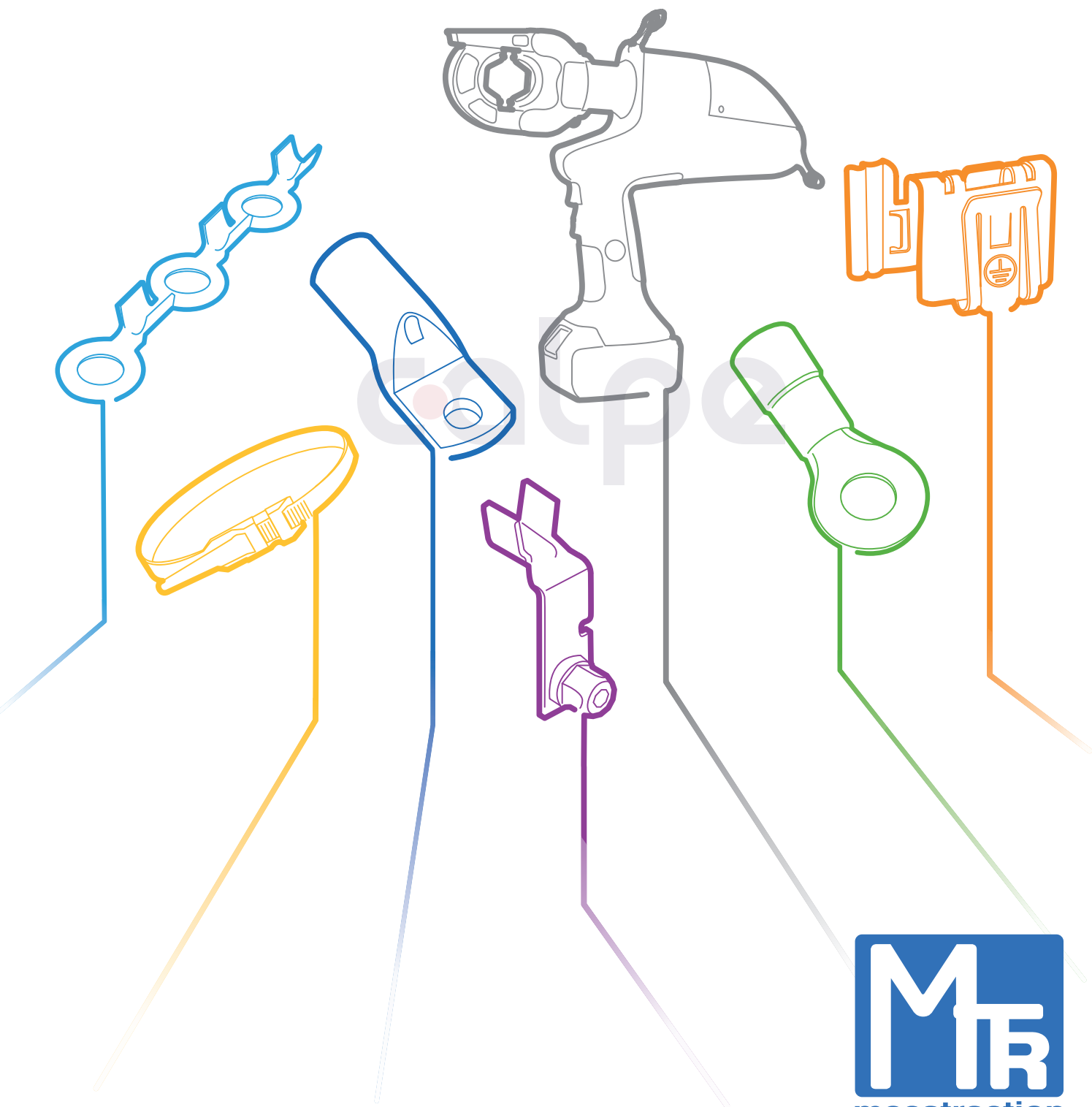

Connecting solutions

Connections and tools for industry, railway, aerospace, automotive, renewable energies and naval.



SICAME GROUP



Connecting solutions

DYNAMIC COMPANY

Founded in 1981, MECATRACTION has become a major player in the field of electrical connections across 5 continents. Headquartered in Pompadour, Corrèze (France), on premises of 9000 m², MECATRACTION offers a complete range of connecting solutions: industrial connectors (lugs, sleeves, end caps, ...), chain industrial connectors, earthing products and mechanical connectors, insulation products, cable ties and accessories, crimping tools. Our solutions are used in a wide range of sectors by leading manufacturers, integrators, installers and electrical equipments wholesalers.

SUBSIDIARY OF THE SICAME GROUP

SICAME is a worldwide industrial Group specialising in products and services relating to the transport and distribution of electrical energy. The group operates in 25 countries over 5 continents with production as well as commercial sites, allowing MECATRACTION to provide local support to customers all over the world.



HIGH PERFORMANCE MEANS OF PRODUCTION

MECATRACTION designs and manufactures in France using extremely flexible and efficient production tools, which can produce with a very high level of quality both small and large series, rely on the latest robotics technologies on the latest robotics technologies. MECATRACTION is expert in trades such as stamping on progressive tool or transfer machine, very large series cutting, assembly and automated control, robotic assembly. In addition we share with SICAME important means of surface treatment.

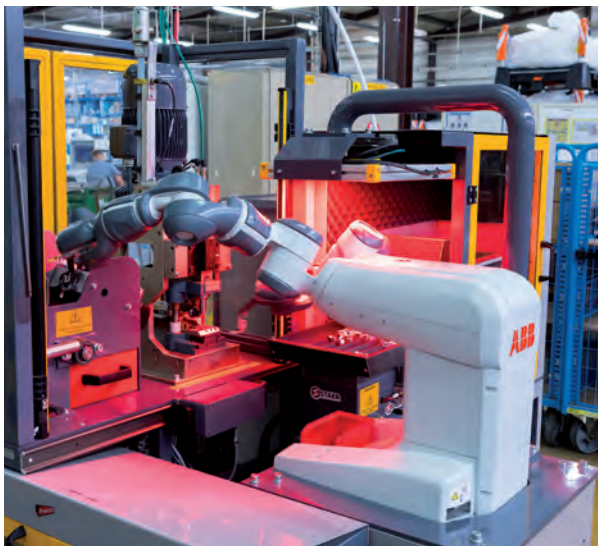



R&D at the heart of our strategy

MECATRACTION designs, develops, and manufactures electrical connections, crimping tools and related services for a large spectrum of applications.

Our crimping expertise is globally recognized and our clients demand for our support in designing solutions answering to ever increasing performance and quality needs.

Our Voice of the Customer approach and global vision allow us to create solutions based on these broad experiences while taking into account economic, technical, and environmental issues.



40 years of experience in **railway**



35 years of experience in **aerospace**



30 years of experience in **automotive**

RESOURCES AND MEANS

- Multidisciplinary team for simultaneous development.
- Research institutes, universities, network of partners in innovative technologies.
- Product development in APQP (Progressive product/ process qualification).
- CAD, CFAO, PLM, CRM tools at the forefront of technology.
- Laboratory performing the investigations, tests and trials necessary to qualify our products.
- Access to the SICAME Group technological tools (IoT, numerical simulation, materials division, rapid prototyping & additive manufacturing).

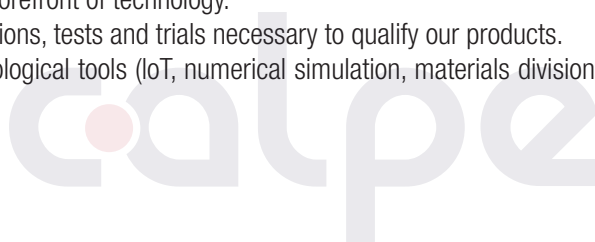

QUALITY SYSTEM

Our teams rely on quality tools such as GRAMS, APQP, PPAP, IMDS, 8D, in line with the different activities benchmarks:



ComEST 2018





Solutions for industrial applications

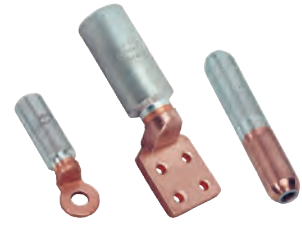

Aluminium-Copper terminal Ends and Butt connectors



Cable Ties and Accessories

Complete range to meet any specifications

MECATRACTION designs, produces and distributes in France and internationally ranges of preinsulated terminals, tubular lugs, terminals with open barrel as well as earthing products and insulation accessories. Our portfolio meets most demands thanks to the respect of the technical requirements and to the products' compliance with French, European and international standards.

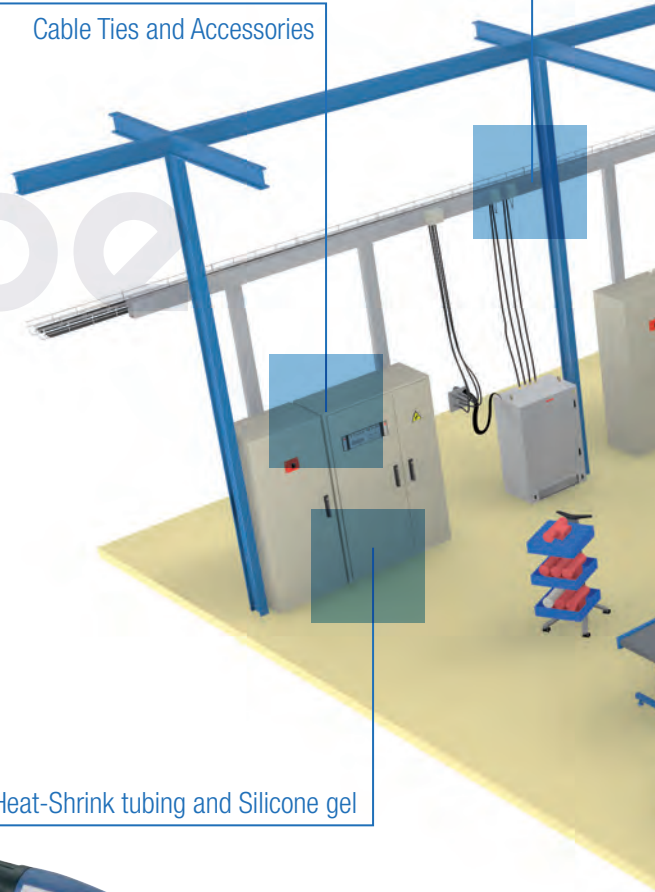

Heat-Shrink tubing and Silicone gel



Tooling





Copper Tubular Lugs and Butt connectors



Bonding clip for Cable Trays



Pre-Insulated terminals



Pre-Insulated End Sleeves

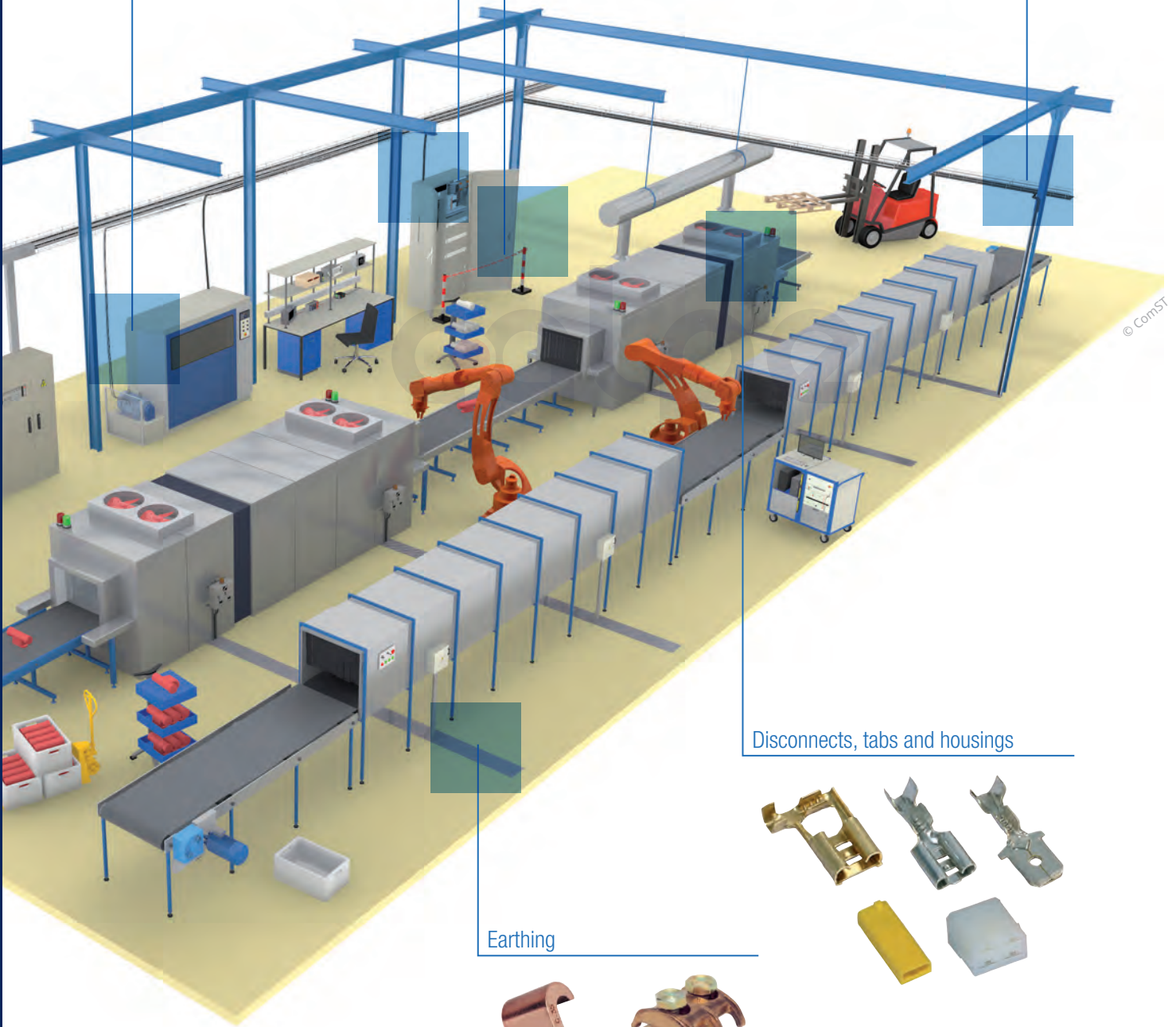

© ComST

Disconnects, tabs and housings

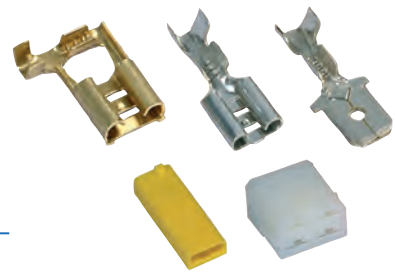

Earthing





Solutions for household appliances

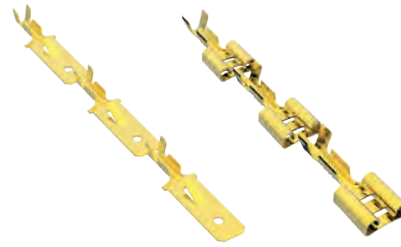

Receptacles and Tabs



Pin connectors and Sockets

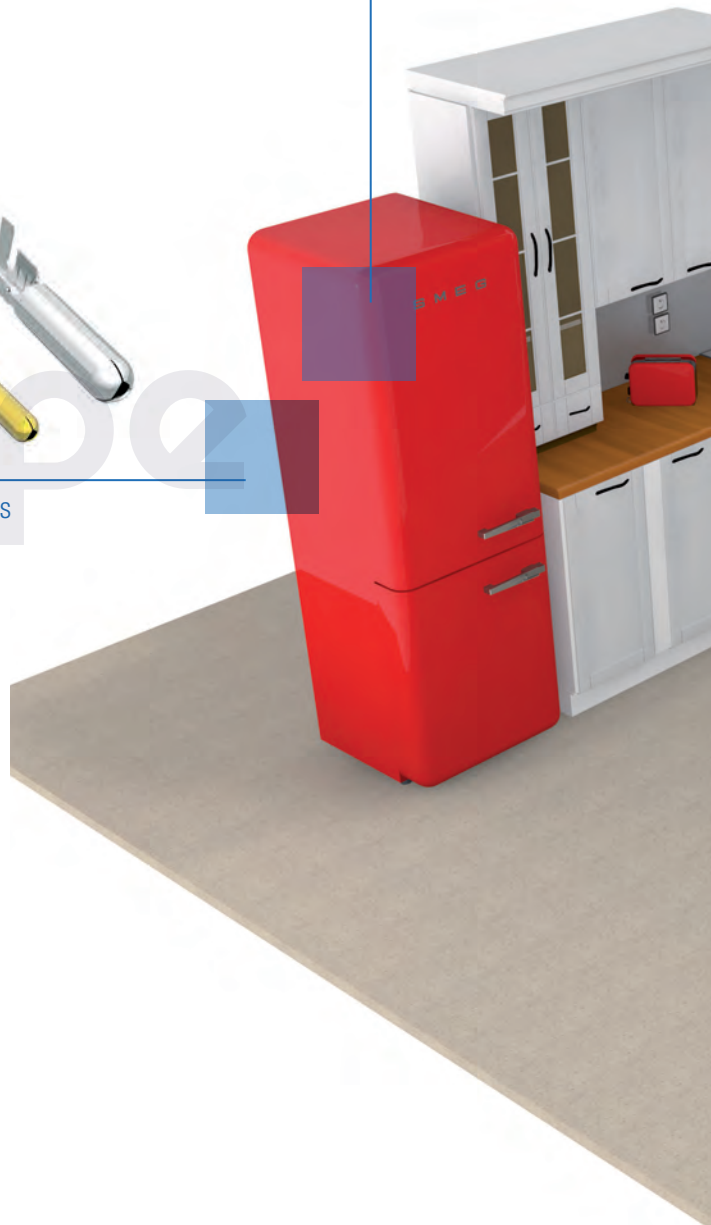

An offer that adapts to your needs

MECATRACTION designs, produces and distributes in France and internationally a range of chain connectors: lugs, sockets, tongues and special cable lugs for household appliances and more generally for equipment requiring this type of connection.

Moreover, we develop custom terminals to support projects or specific manufacturing needs.

Tooling



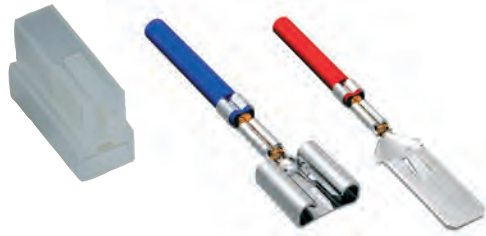

Receptacles, insulation sleeves and housing



Loose Tabs

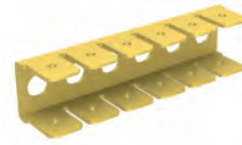

6.35 Loose Tabs

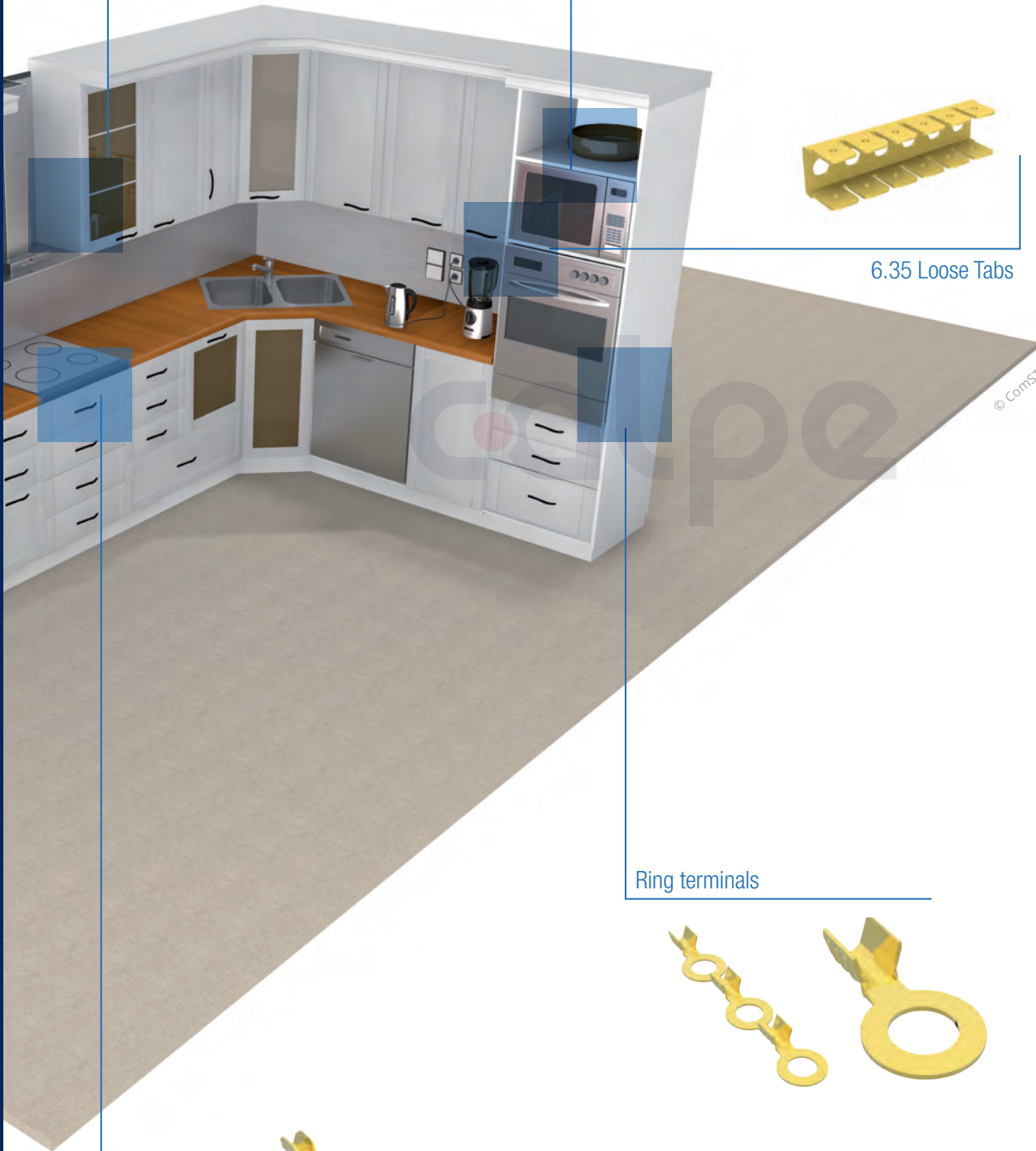

© ComST

Ring terminals



End splices

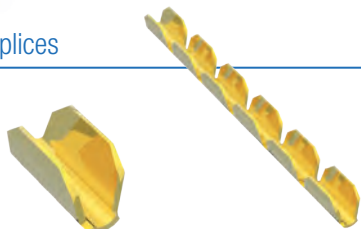



Solutions for renewable energies



Connectors for equipotential bonding

Innovative products to support the energy transition

MECATRACTION designs, produces and distributes in France and internationally an innovative connection range for renewable energies. Therefore, by our crimping know-how, we contribute to an improved energy efficiency.



Tooling





Copper tubular lugs



Earthing connections



Connectors for equipotential bonding

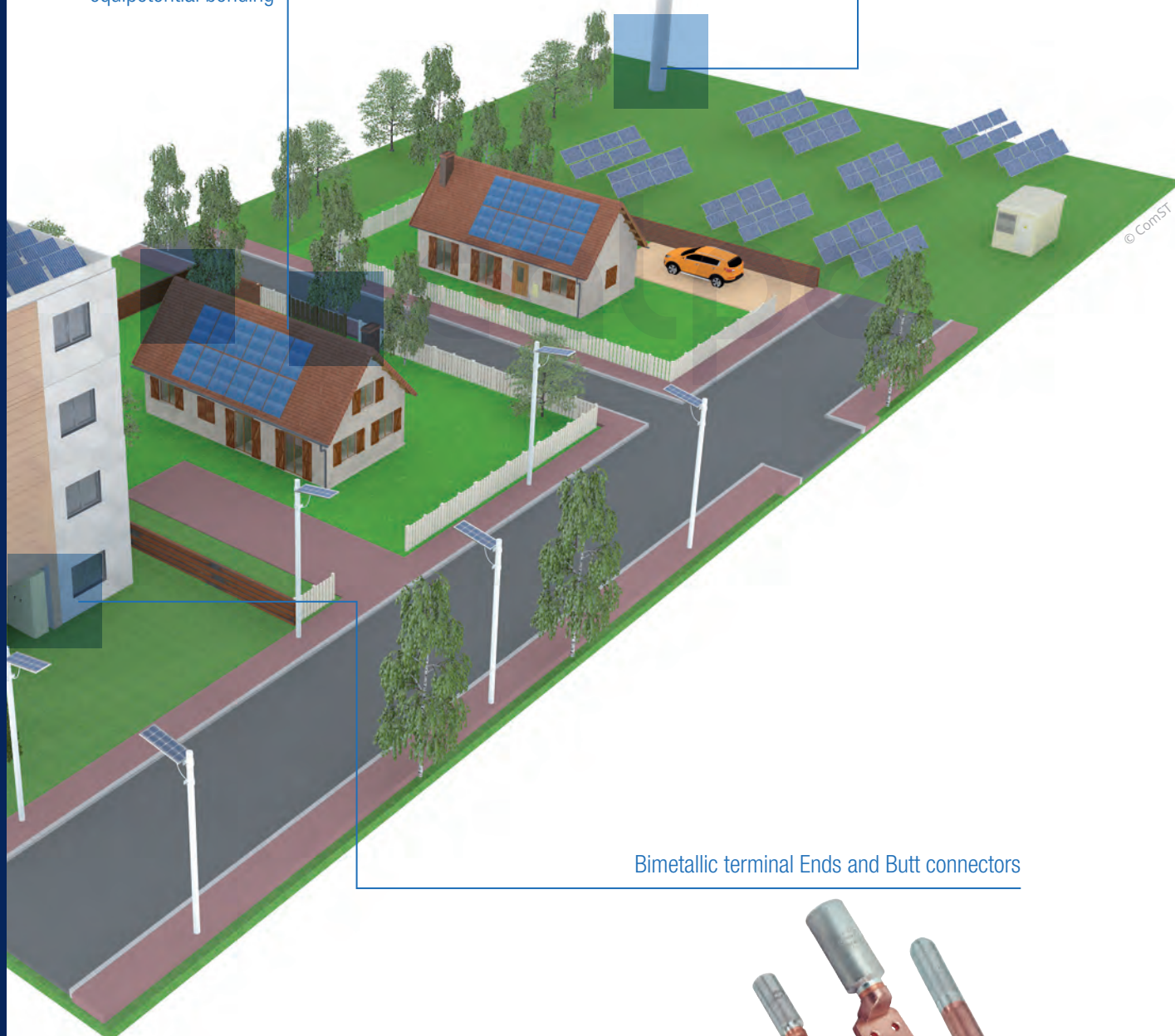

© ComST

Bimetallic terminal Ends and Butt connectors





**Solutions for
aerospace**



Nickel-plated aluminum lugs

Aerospace range

MECATRACTION designs and produces connecting solutions for aerospace applications. As a partner of the world's leading aircraft manufacturers, we provide our expertise and experience to support projects in compliance with quality and traceability requirements.



Tooling





Nickel-plated copper lugs

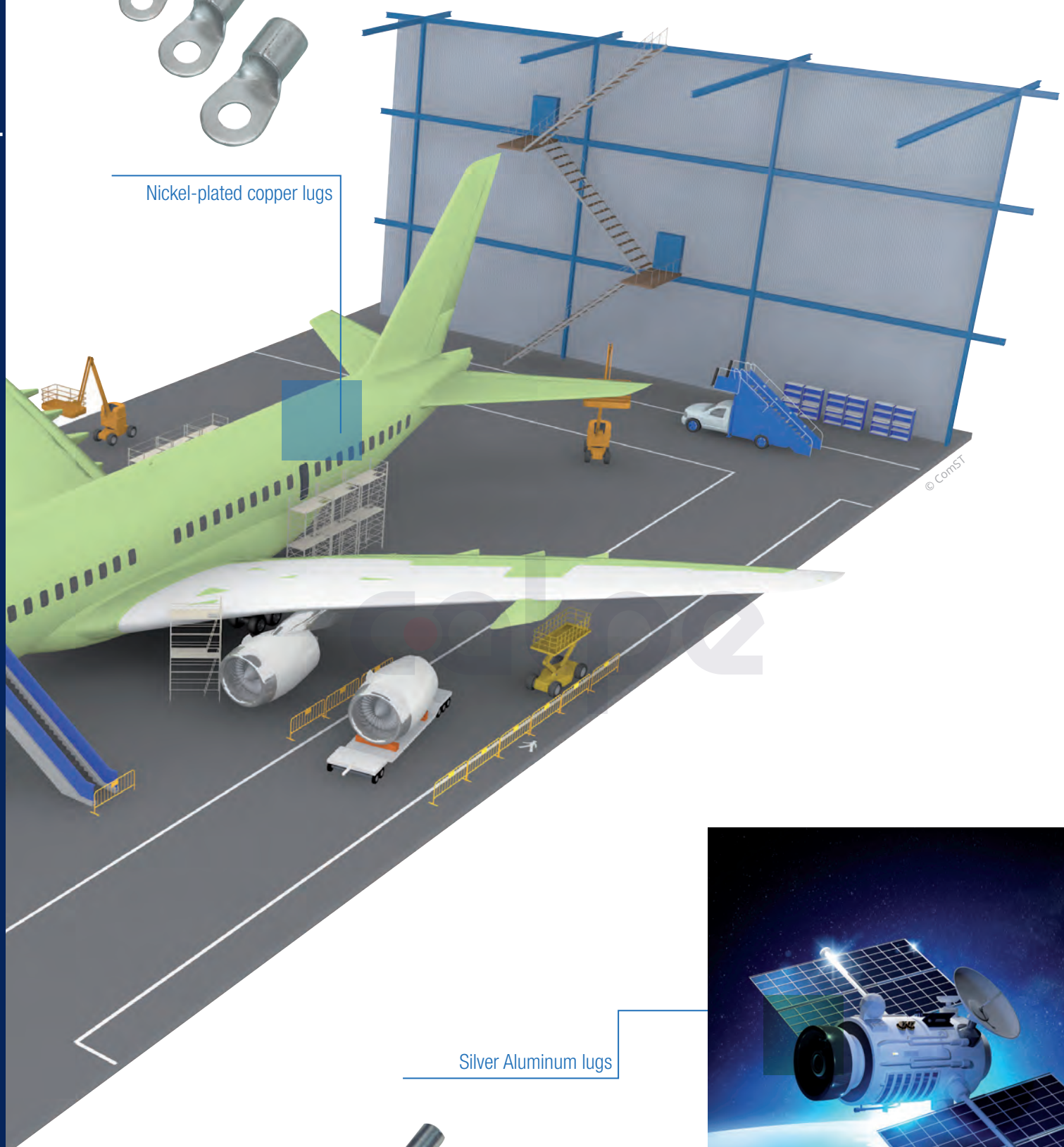

© ComST

Silver Aluminum lugs





Solutions for automotive and heavy vehicles



Alternator terminals

Watertight Ground terminals for electronic parts



Starter terminals

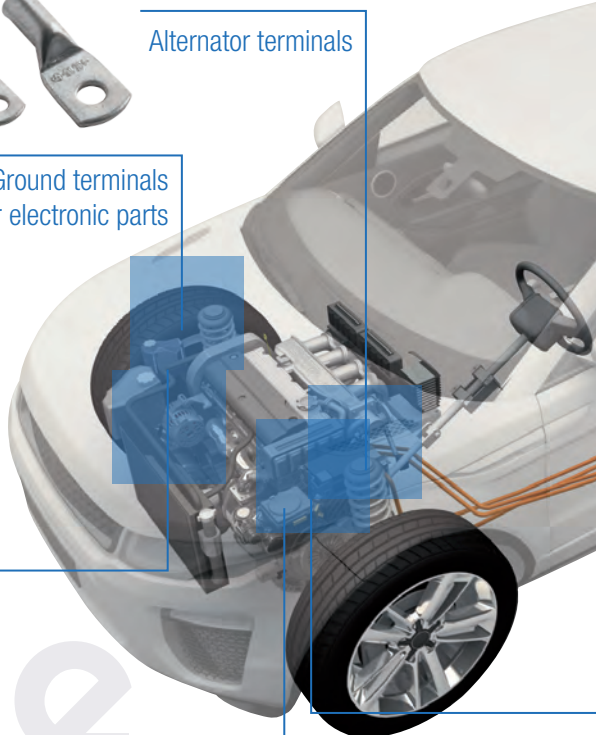

Electrical housing terminals



Starter terminals

Automotive connections, a mastered know-how

As a partner of the leading French and European manufacturers, MECATRACTION designs products and connecting solutions for cars, buses, and trucks. Our know-how and expertise in mastering connections' performance are highly regarded during the current industry transition to hybrid and electric vehicles. MECATRACTION participates to the conception of new platforms and models, proposing innovative solutions to R&D teams.

Ground terminals



Alternator terminals





Shunts

Watertight Tubular Lugs for hybrid vehicles

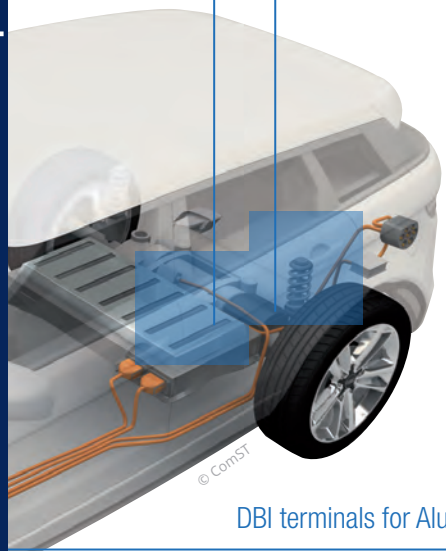

© ComST

DBI terminals for Aluminum cables

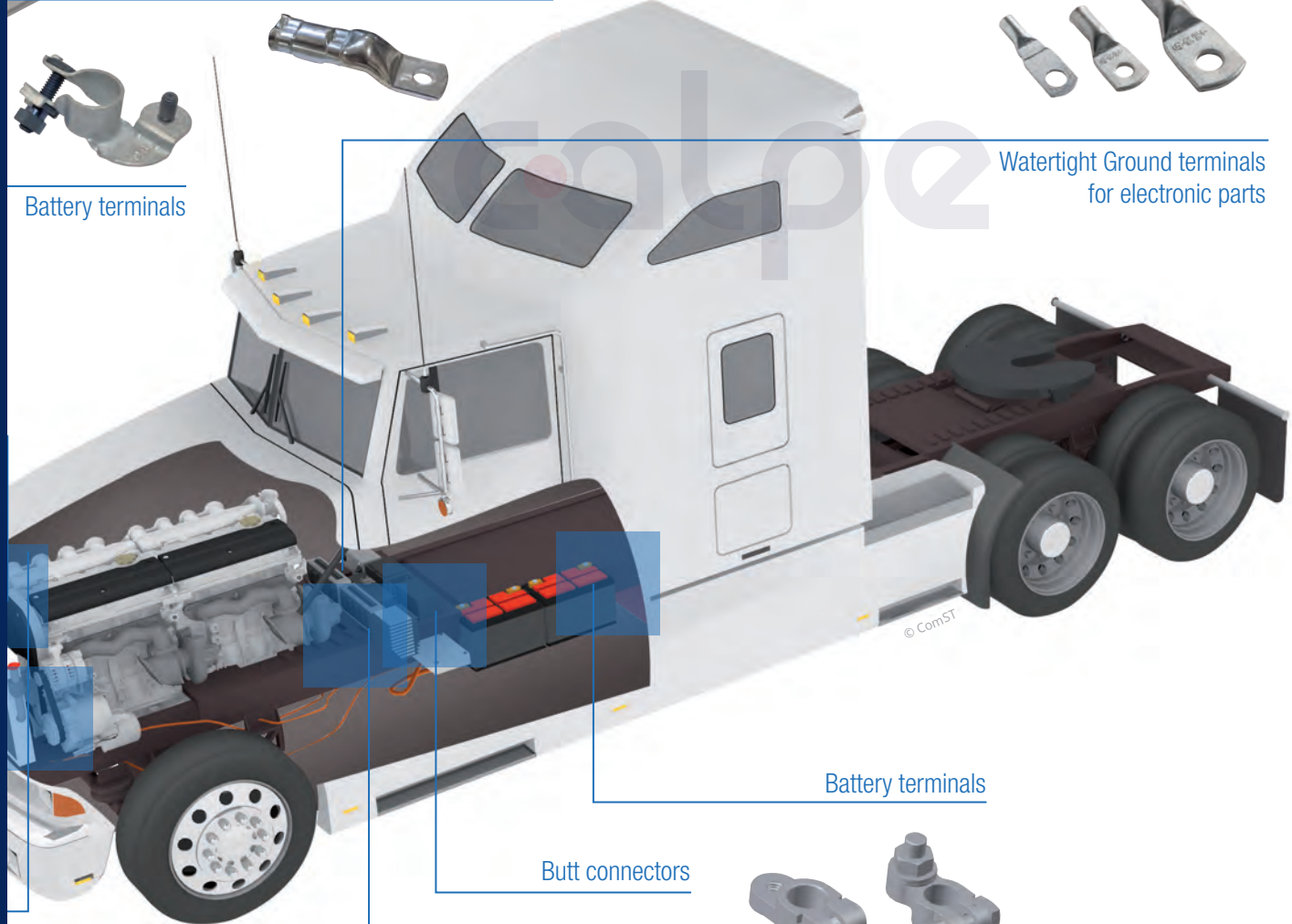

Battery terminals

Watertight Ground terminals for electronic parts

Battery terminals

Butt connectors

Electrical housing terminals





Solutions for railway



Signalling terminals



Power Tubular lugs



Pre-insulated terminals

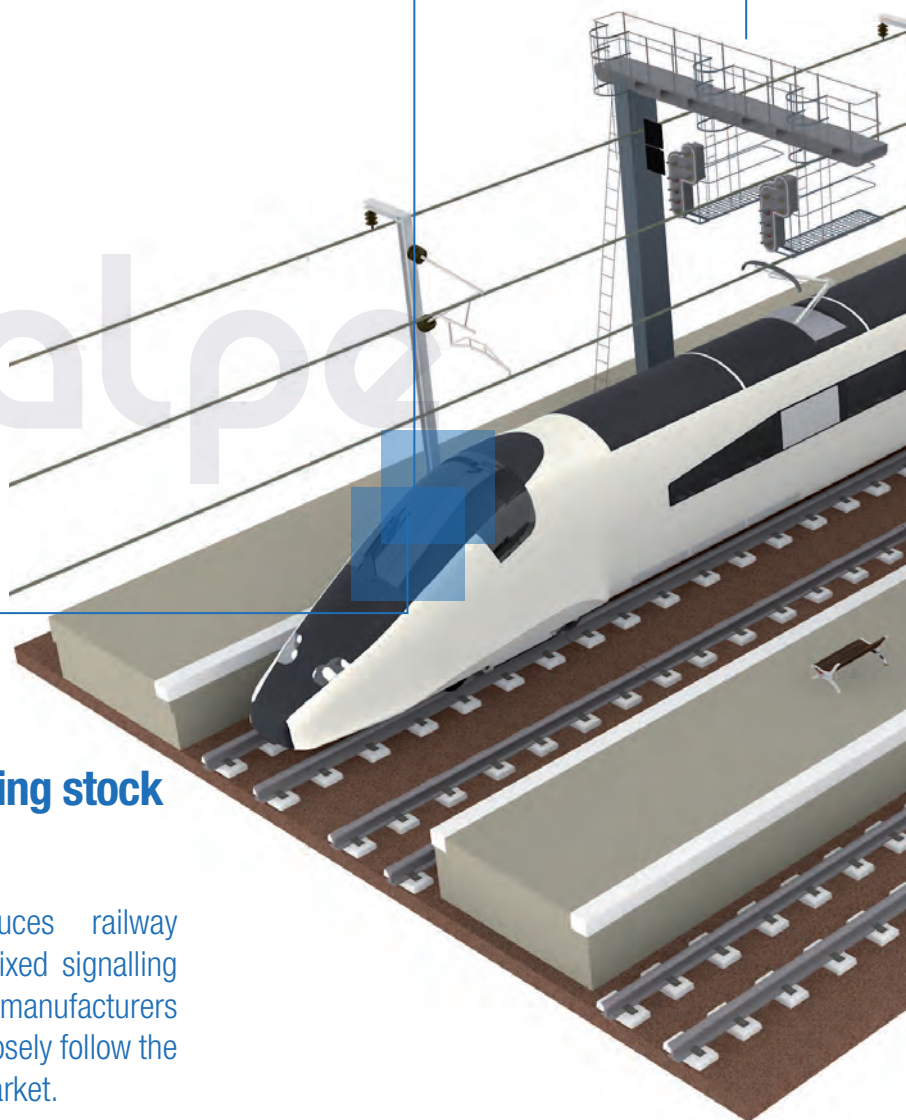

Railway connections for rolling stock and signalling systems

MECATRACON designs and produces railway connections for both rolling stock and fixed signalling systems. As a supplier of leading train manufacturers and national rail network operators, we closely follow the major trends of this rapidly developing market.

Tooling



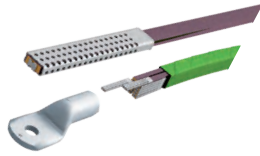

Embedded transformer terminals



Back traction
Tubular lugs

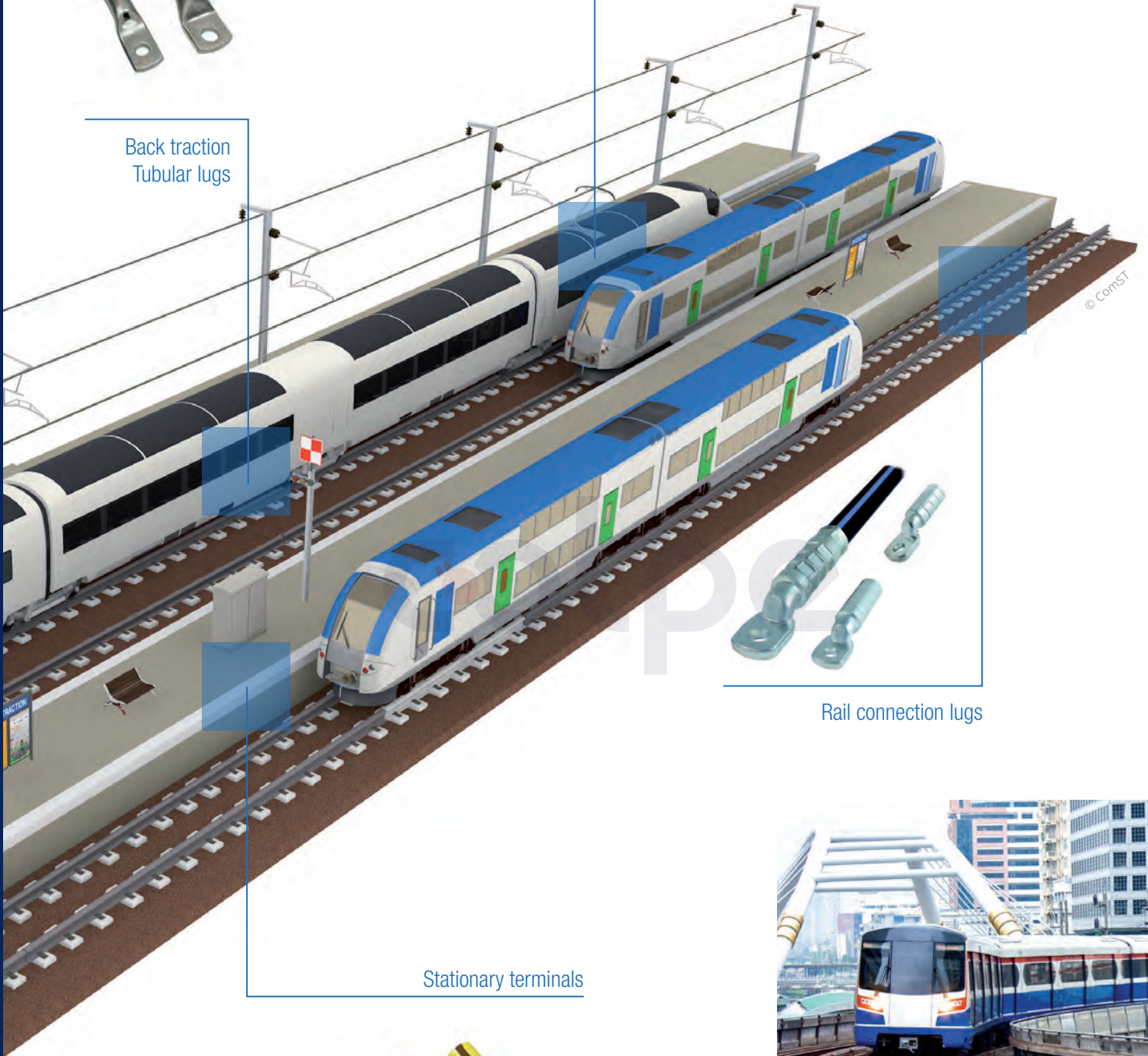

© ComST



Rail connection lugs

Stationary terminals





Crimping solutions



Mechanical and Electro-hydraulic Tooling



Tooling for pre-insulated terminals

Complete range of crimping and cable preparation tools

MECATRACTION designs and produces a complete range of crimping and cable preparation tools, including a high-performance and connected range of electro-hydraulic tools that can be used for all types of lugs.

MECATRACTION offers an after-sales and maintenance service for all its portfolio.

Tooling for end sleeves



Cable-cutter, stripping tools and punches



Crimping Know-How



Standard Hexagonal Crimp

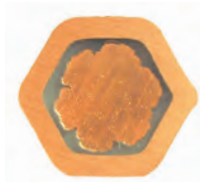

Watertight Crimp on Cable Insulation

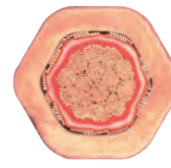

Shielding Connection by Crimping



Open Barrel Connection Crimp



B Crimp on Flexible Copper Cable



Deep Indent on Aluminum Cable for Aerospace Industry

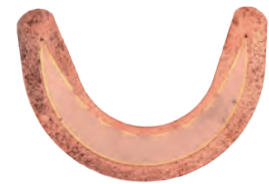

Deep Indent on Aluminum Flexible Cable



Supports and services

Our technical sales department offers technical support services tailored to your needs.

Training

A team of trainers at your service

MECATRACTION offers to its customers in-depth trainings, stemming from product selection, to cable preparation and to crimping techniques.

Such trainings can take place at our premises or at customers'.

After-sales service

Our experts at the service of your tools

MECATRACTION has a workshop dedicated to the after-sales service of its tools.

Your mechanical, pneumatic, electrical or hydraulic tools are controlled, checked and repaired by highly qualified experts. Verification reports are issued after inspection or repair.

Itinexpo

Our experts close to our customers

MECATRACTION can further support its customers thanks to its fully equipped mobile unit Itinexpo.

Itinexpo provides technical assistance customized to the customers' needs: demonstration, tooling commissioning and inspection and crimping training. With a simple phone call, our customers can benefit of this unique service at their premises or at Mecatracting's Headquarters.

Technical support

1. Assistance with product selection

Technical advice, studies and expertise, specific solutions, training.

2. Technical assistance for crimping tools

Demonstration, commissioning, maintenance, repair, inspection/verification, training in crimping techniques.



For any information contact us :
 +33 (0)5 55 73 89 80
service.technico@mecatraction.com



Our connecting solutions are mobile and offer technical assistance for crimping and cable preparation tools.

DEMONSTRATION
COMMISSIONING
CONTROL AND VERIFICATION ON YOUR PREMISES
TRAINING TO CRIMPING TECHNICALS

Our mobile unit «ltinexpo» and our experts at your premises on request.

This documentation is not contractual.

The items listed are offered within the limits of available stocks.

MECATRACTION SA reserves the right to interrupt products' production or modify their characteristics without notice.

Pictures credit : © solarseven_123rf.com / © dell, © Srinakorn Tangwai, © metlion, © phadventure, © Vladimir Vydrin, © Camp's, © arsdigital_fotolia.com

© 2019 Mecatracting S.A.

All rights of reproduction, adaptation and translation reserved for all countries.



Connecting solutions

www.mecatraction.com



MECATRACTION
ZA Les Hauts de Chignac - 19230 POMPADOUR - FRANCE
Phone: +33 (0)5 55 73 89 89 - Fax: +33 (0)5 55 73 32 21
E-mail: info@mecatraction.com



SICAME GROUP

CALPE.NL